

UNIVERSAL DIMMER DIM04SA/500U

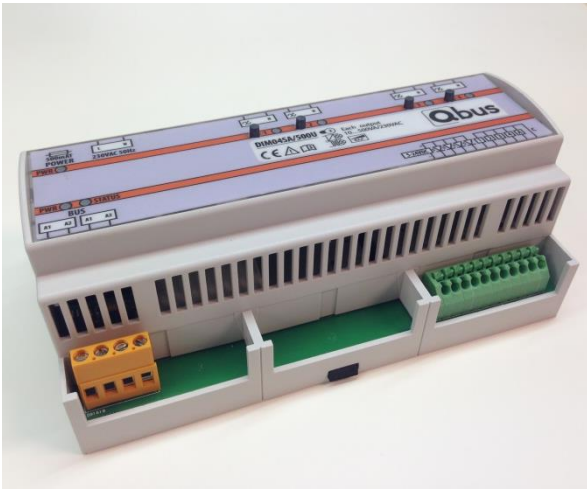

Figure 1 : Dimmer module DIM04SA/500U

1. Product Description

This module can function both Stand-Alone (so WITHOUT Controller, WITHOUT external power supply) but can also be connected to a Controller to become part of a full-fledged Qbus installation.

The DIM04SA/500U is a DIN-rail module, suitable for dimming 4 loads of 10-500VA. The dimmers operate digitally with 8 bit precision. An optical separation between the inputs and outputs guarantees safe operation. The DIM04/500U can be used with incandescent lamp, halogene lamps, capacitive loads, inductive loads, certain dimmable energy-savings lamps and dimmable 230V LEDs.

WARNING: Dimmable energy-savings lamps and 230V LED-lamps will need to be set to a minimum dim-value via the Qbus Configuration software. These minimum-values need to be set when the lamp is cold. Dim-values which are too low will cause the lamp to oscillate and can significantly reduce the expected life of the lamp.

If the Dimmer is used in Stand-Alone mode, the connected load and minimum dim-value can be set manually for each circuit. See below under “Manual Control” for more details on how to set these values. If the dimmer is used as part of a full Qbus installation (with a Qbus Controller), the load and minimum dim-value can be set via the Qbus configuration software.

DIM04/500U is short-circuit resistant, has overvoltage and overheating protection and has a built-in CRC filter (Filters central remote control signals when applicable, to prevent oscillation and buzzing of lamps and fittings in areas with high electricity network pollution). When the dimmer goes into safety mode because of

overheating, overvoltage or short-circuit, the red ERROR-LED will be on. The output can be reset by putting it in the OFF-status.

The DIM04SA/500U module also has 5 potential-free inputs to connect standard push buttons. Input 1 to 4 control respectively output 1 to 4, input A is a scene-input which executes an ALL OFF-scene when pushing for 0,7 seconds (and then releasing the button), or a PANIC-scene (All Outputs on) when pushing the button for 3 seconds. The inputs are set standard in push button mode. When the DIM04SA/500U is connected to a controller, the input mode of the DIM04SA/500U can be changed to Normal Open, Normal Closed or toggle.

The module also contains four LED outputs to be used as feedback on swathe push buttons. In order to use the LED feedback, an external 24V power supply needs to be installed.

The dimmer outputs can only be used as a one-button dimmer. As a one-button dimmer the dimming cycle must always be completed: starting from zero to maximum and back to zero. A short pulse (< 0.3secs.) will take the dimmer to zero or to the maximum value in 2.5secs. The maximum value can be adjusted from 5% to 100%. The lighting can also be dimmed automatically after a set time of 1 sec to 255mins.

If the dimmer is controlled via a scene, the cycle time for 0%-100% or vice versa can be set between 0,3 seconds and 20 minutes.

Each module has a unique serial number enabling programming anywhere and anytime. After a voltage cut-off the outputs return to their latest position.

The DIM04/500U is protected with a 500mAT fuse. Ensure adequate ventilation in the fuse box. A bipolar automatic fuse of a maximum of 16A must be placed on the mains power.

2. Safety Instructions

Read the complete manual before carrying out the installation and activating the system.



WARNING

- The device must be mounted, serviced and commissioned, by an authorized electrician in accordance with the country-specific regulations.
- This device is exclusively suitable for DIN-rail mounting EN 50022. It must be mounted in a fire-proof closed distribution board and should be well ventilated. Air ventilation must be ensured.

UNIVERSAL DIMMER DIM04SA/500U

- A safety disconnection of the device must be possible. Before servicing the DIM04/500U the mains voltage should be disconnected.
- Only transformers that are approved for dimming operation may be used. Pay attention to prevent no-load operation of conventional, dimmable transformers during commissioning or during operation.
- The Dimmer is intended to work with incandescent lamp, halogene lamps, capacitive loads, inductive loads, dimmable energy-savings lamps and dimmable 230V LEDs. Mixed operation of different load types is not permitted.
- The device must not be opened. Warranty will be void if the module has been opened.

3. Mounting and wiring

The DIM04SA can be used in different installation configurations. Following specifications however will remain the same across the different configurations:

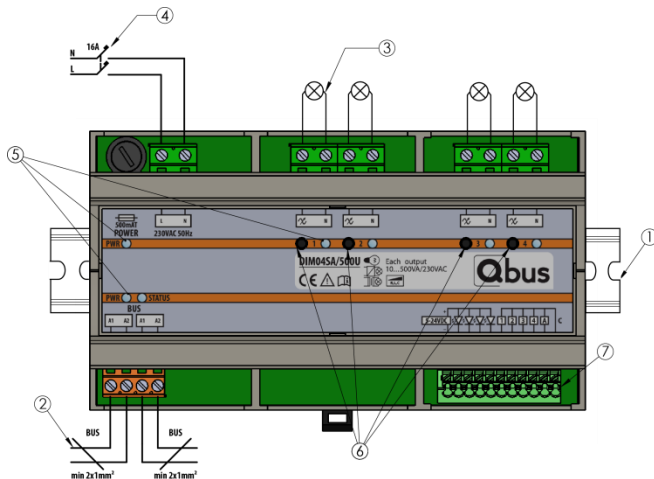

FITTINGⓄ :

This device is exclusively suitable for DIN-rail mounting EN 50022.

LOAD CIRCUITSⓄ:

Connect the loads. Conductor cross section : minimum 1,5mm².

Remove approx 7mm of insulation from the wire and screw it into the terminals 1 – 4.

The DIM04/500U can be used with incandescent lamp, halogene lamps, capacitive loads, inductive loads, certain dimmable energy-savings lamps and dimmable 230V LEDs. The load can be chosen via the System Manager software or using the buttons on the DIM04SA module as described below under “Manual Control”.

POWER SUPPLYⓄ :

A bipolar automatic fuse of a minimum of 16A must be placed on the mains power 230Vac.

Conductor cross section : maximum 1,5mm².

Remove approx 7mm of insulation from the wire and screw it into the terminals Ph-N.

WARNING: BEFORE WORKING ON THE DEVICE DISCONNECT THE SUPPLY VOLTAGE.

INPUTSⓄ:

Both solid and stranded wire between 0,5 – 1,5 mm² can be used (for stranded use a screwdriver to push on the connection when inserting the wire). Remove approx 7mm of insulation from the wire and push it into the input terminals 1-A. By pushing with a screwdriver on the connector, the wire can be removed from the connector. Input 1/2/3/4 controls respectively output 1/2/3/4. Input A is set as a scene-input. Pushing the pushbutton connected to Input A for 0,7 seconds will turn all outputs on the REL04SA OFF. Pushing the same button for at least three seconds will turn all outputs ON.

LED OUTPUTSⓄ

An external 24V power supply can be connected to the REL04SA in order to provide LED-feedback on the push buttons.

LED INDICATIONⓄ :

Green led : power supply.

Red “STATUS”-led: start-up 2 seconds and during programming. This LED will also flash while selecting the load and the minimum dim-level.

Orange Leds 1-4 continuously on: output active. These LEDs will flash if the respective output has gone into safety-mode (overheating, overload, short-circuit). Bring the output back to its OFF-status, the orange led will be turned off and the output can be controlled again (if the issue causing the safety-mode has been resolved).

MANUAL CONTROLⓄ:

Used to directly control the outputs of the module or to select the connected load and the minimum dim-value if the dimmer is used in Stand-Alone mode. Each output can be controlled via the button under the respective output. To select the connected load, follow this procedure:

- 1) Ensure all outputs are OFF (= all orange LEDs are off).
- 2) Push both the buttons under output 1 and output 2 simultaneously for 4 seconds.
- 3) The red STATUS LED on the module will flash fast during 5 seconds, and will then start to flash at a different speed.
- 4) 2 seconds after the STATUS LED has been flashing at a different speed, release one of the two

UNIVERSAL DIMMER DIM04SA/500U

buttons; 2 seconds later release the other one. The red STATUS LED will now continue to flash; the module is in configuration mode.

- 5) The outputs are standard set for Conventional transfo's. If other loads need to be dimmed, the respective load can be selected by pushing a number of times on the button underneath that output. The orange LED will lighten up each time the button has been pushed. See table below - next to the load type you will find the number of times the button of that output needs to be pushed:

Load	Choice
Conventional transformers	1
Electronic transformers	2
Incandescent lamps	2
Halogen lamps 230V	2
Retrofit led 230V (preferable)	2
Retrofit led 230V (alternative)	1
CFL with 100% startup (preferable)	3
CFL with 100% startup (alternative)	4

If no buttons have been pushed during 4 seconds, the module will get out of the configuration mode and the red STATUS LED will stop flashing.

- 6) The minimum dim-level can also be set in Stand-Alone mode. Follow steps 1 to 4 above to get back in to the configuration mode. See table below to find out how many times the button needs to be pushed to select a certain minimum dim-level:

Low Dimming Limit (DimMin)	Choice
0%	5
10%	6
20%	7
30%	8

If one of the buttons during configuration mode is pushed for 5 seconds, that output will be put back in to factory settings (= Conventional transformer and 10% minimum dim-level). A successful RESET will be shown by 10 flashes of the orange LED of that channel.

REMARK: if you want to select a certain load for an output, and also select a minimum dim-level for this same output, you need to put the module in to configuration mode, select the load (push 1 to 4 times), get out of configuration mode, get back in to configuration mode and select the minimum dim-level (push 5 to 8 times).

Following energy savings lamps and 230V LED-lamps have been testen on the DIM04SA/500U:

- GE:**
- LEDPAR30
 - Electronic CFL 20W

- Megaman**
- Dimmable energy savings lamp 8W, 11W 2700K
 - Dimmable LED 8W 2800K.
- Osram:**
- Dimmable energy savings lamp DULUX Superstar 14W
 - 230V LED Parathom PAR16 50 (advanced)
- Philips:**
- dimmable LED 6W 2700K, 7W 3000K 40D, 12W 2700K 25D,
- Meanwell:**
- PCD-16-350B met 2x AL10430 spots
 - PCD-16-350B met 3x activeline Luga

CABLING OPTIONS

Option 1: Stand-Alone

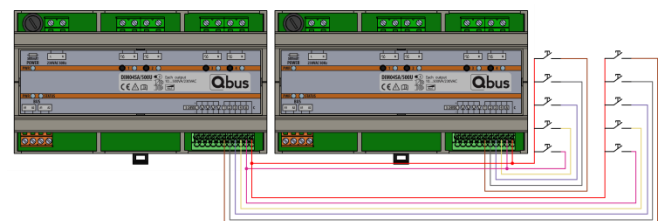
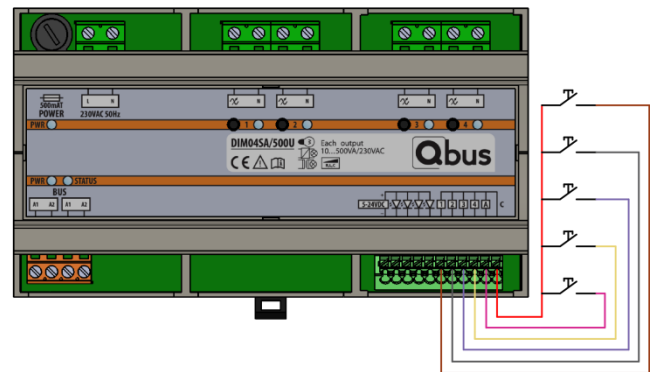

Multiple REL04SA modules can be connected with each other.

Option 2: Stand-Alone with LED-feedback

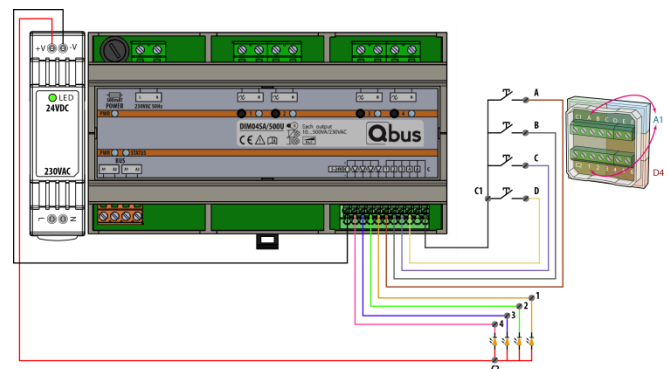

UNIVERSAL DIMMER DIM04SA/500U

With extra 5-24V power supply for LED-feedback on push buttons. Here in combination with a Niko push button type 170-401Y1 or 170-401Y0

Option 3: with controller as part of a complete Qbus system

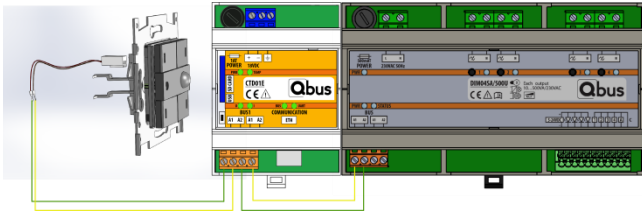

- ✓ No module, switch or push button needs to be replaced.
- ✓ A Qbus controller provides all-in- and output modules power and data via the two-wire bus. This module contains clocks, scenes, presence simulation, logic,... Via the Ethernet port of the controller, the installation can be connected to the internet and can be controlled remotely via smart phones, tablets etc.
- ✓ It is recommended to use the EIB cable or any other cable with minimum 2 x 1mm² conductors as bus lead.

4. Technical Data

GENERAL SPECIFICATIONS :

- Power supply : 230Vac +-10%, 50Hz - maximum protection 16A/2P .
- This device is exclusively suitable for DIN-rail mounting EN50022.
- Insulation voltage : 3 kVac tested
- Characteristic consumption : 4.5VA
- Ambient temperature :
Working temp. range : 10°C to 70°C
Storage temp. range : -10°C to 70°C
- Maximum humidity : 93%, no moisture condensation
- Bus load : 10mA at nominal 13,8V
- Fuse : 500mAT single-phase
- Max installation altitude : 2000meters

OUTPUTS :

- 1 – 4 : dimmable outputs for halogen, incandescent, dimmable 230V LED and dimmable CFL lamps.
- Maximum load :
Incandescent / halogen with electronic transfo: max 500VA at 230Vac each circuit
Halogen with classic (magnetic) transfo max 400VA at 230Vac each circuit

- CFL and 230V LED lamps max 100W each circuit
- Minimum load :
Incandescent / halogen / 230V LED load: 10VA at 230Vac each circuit
CFL lamps 10W each circuit

PHYSICAL SPECIFICATIONS

- Housing : Plastic, self-extinguishing acc. to UL94-V0
- Protection Degree : IP20, EN60529
- Installation : rapid mounting on DIN-RAIL, width 9 modules
- Dimensions (HxWxL) : 62mm x 90mm x 161mm
- Weight : approx. 0,400 kg

ELECTRICAL SAFETY

- Bus : 13,8VDC safety extra low voltage.
- Complies according EN60950-1:2006.
- Dielectric strength: module has been tested (and approved) 3kVac. (50Hz, 1 min.)
- Non-toxic WEEE/RoHS compliant.
- Class II equipment. 

CE

- Complies with the EMC regulations and low voltage regulations. The device complies with HBES – EN50090-2-2:2002 and EN60950 – 1 : 2006 +A11:2009 + A1:2010 + A12:2011 + A2:2013.

5. Dimension Diagram

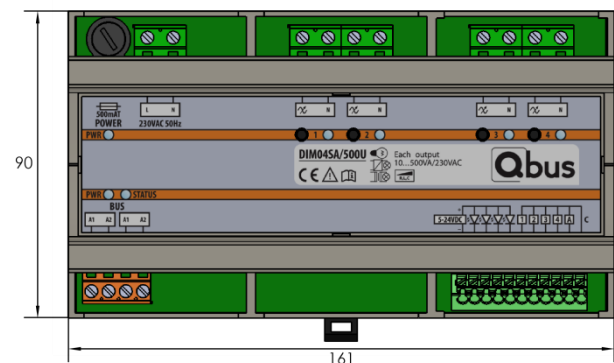

UNIVERSAL DIMMER DIM04SA/500U

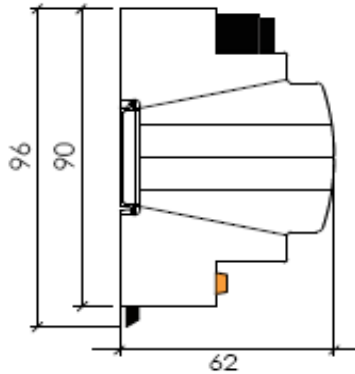

Width = 9 modules, 1 Module = 17mm.

6. Guarantee provisions

Period of guarantee: 2 years from date of delivery. Any faulty devices should be send postage-free with a description of the defect to our customer service office :

QBUS N.V.

Joseph Cardijnstraat 19

9420 Erpe-Mere

Belgium

Tel : +32 (0)53 60 72 10

Fax : +32 (0) 53 60 72 19

Email : support@qbus.be