

## Suspended Down Light

20W

## Data Sheet

760-0104

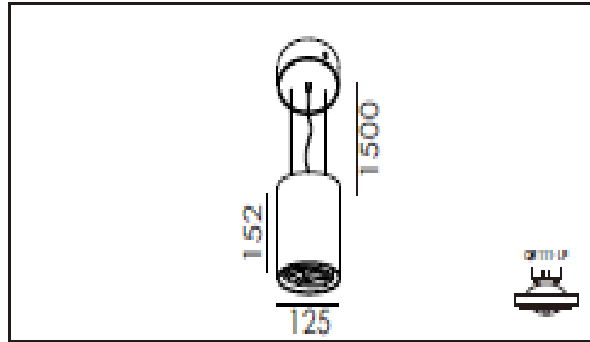

### APPLICATIONS

LED ceiling and wall luminaire made of aluminum and hand-blown crystal glass.

For a variety of interior and exterior lighting applications.

The used LED technique offers durability and optimal light output with low power

### PRODUCT SPECIFICATIONS

- Luminaire made of Aluminum
- LED with a Lens of Optical
- Dimensions : D125\*L152mm
- LED : COB
- Finish : White
- Correlated Color Temperature (CCT) : 2700K
- Lumens : 2000 lm
- Color Rendering Index (CRI) : 80
- Reflector Degree (°) : 36
- Power Factor : 0.9
- Net Weight : 1.63Kg
- LED power supply unit : Input (AC): 220 - 240V 50 Hz  
Non - Dimmable
- Luminaire: Protection class IP 20 : Protected against Solid Foreign Objects  
(ø 12.5mm)